

Arch Inserts

Arch Insert

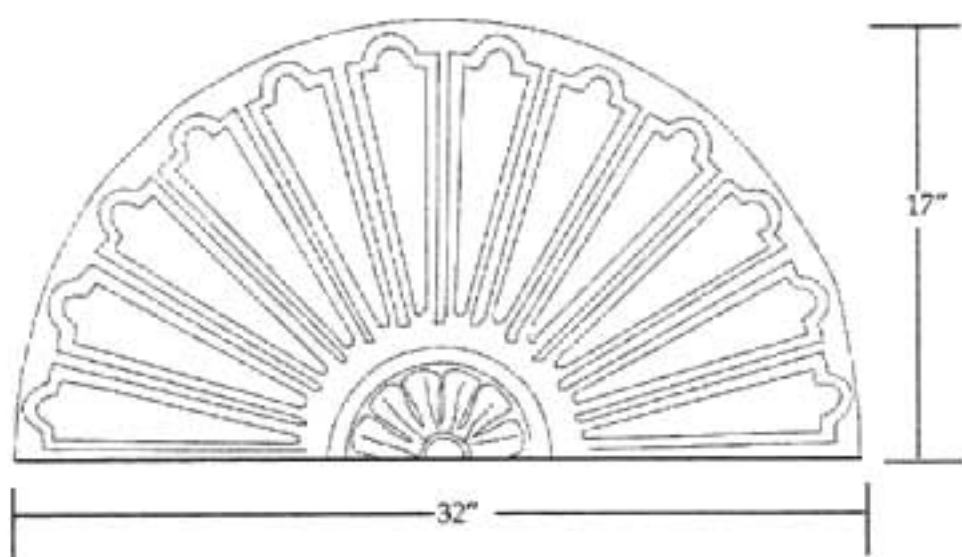

Arch Inserts

Morgan Arch Insert

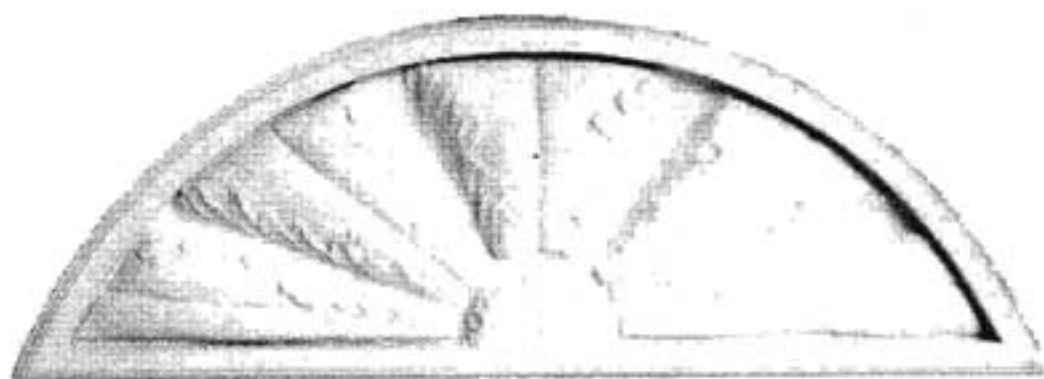

Arches

Plain Arch

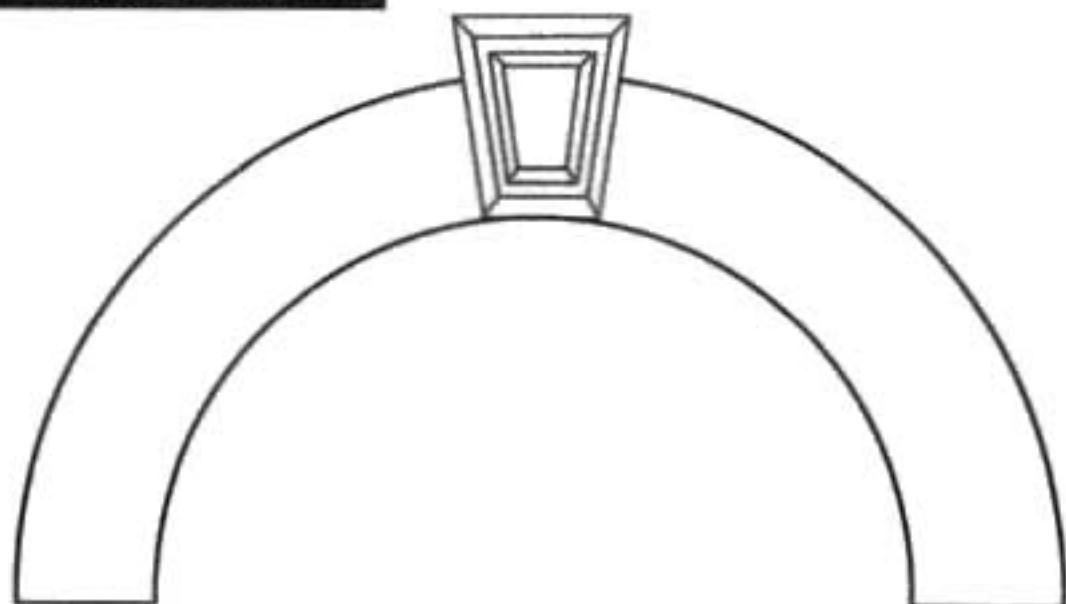

Beveled Arch

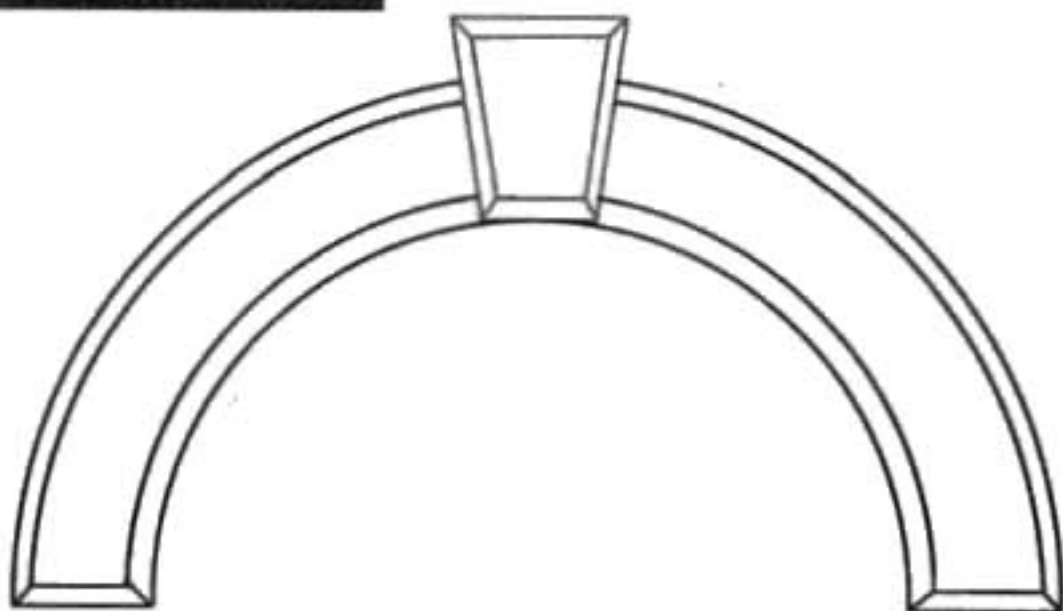

Arches

Plain Arch

Arches are available
in the following heights:

6"
8"
10"
12"

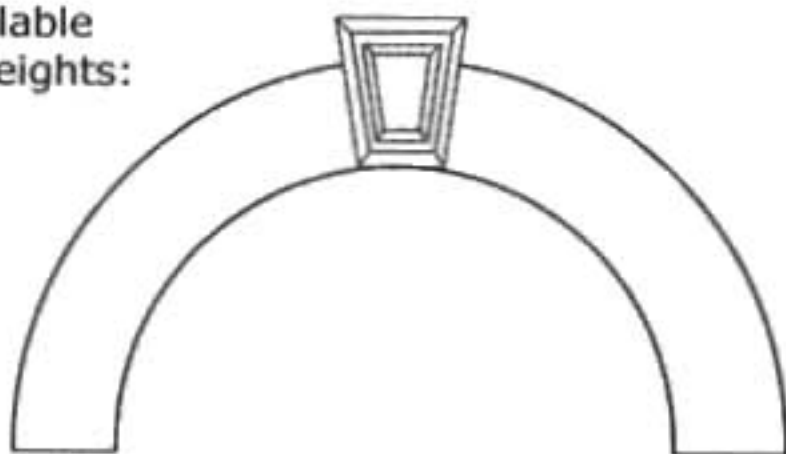

Beveled Arch

Arches are available
in the following depths:

4"
8"
12"
16"

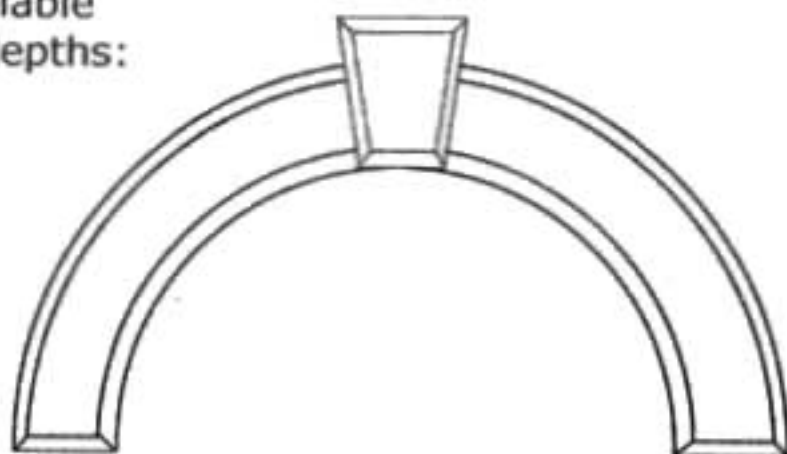

Balls & Bases

8" Ball & Base



10" Ball



12" Ball



20" Ball



Balls & Bases

8" Ball & Base



10" Ball

With collar on bottom for setting and pinning.



12" Ball

With collar on bottom for setting and pinning.



20" Ball

With collar on bottom for setting and pinning.



Ballustrades

Classic



Colonial

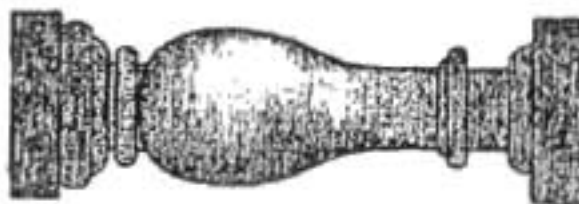

Dwarf

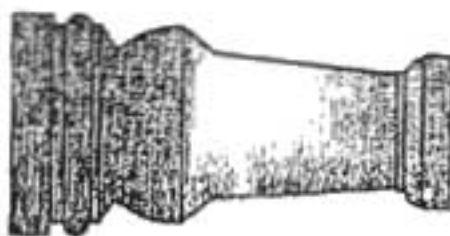

Excalibur



Banding

Plain



Beveled

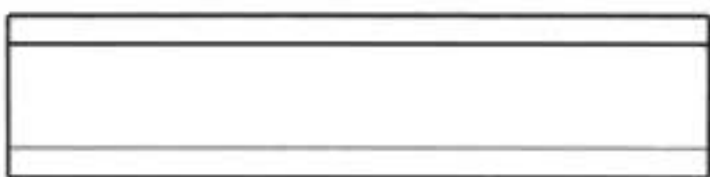

3/4" Round

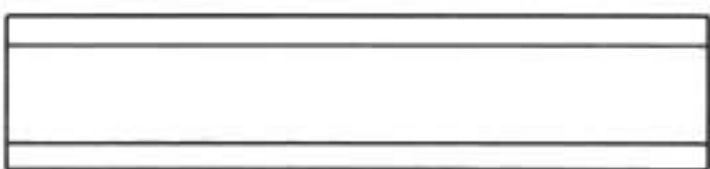

Cove

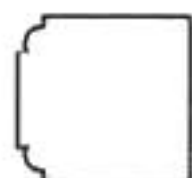
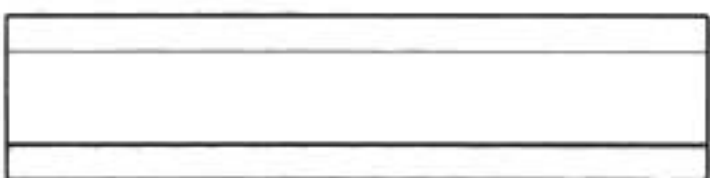

Banding

Plain

4" x 3⁵/₈" x 47⁵/₈"

5" x 3⁵/₈" x 47⁵/₈"

6" x 3⁵/₈" x 47⁵/₈"

8" x 3⁵/₈" x 47⁵/₈"

10" x 3⁵/₈" x 47⁵/₈"

12" x 3⁵/₈" x 47⁵/₈"

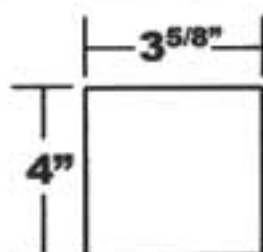

Beveled

4" x 3⁵/₈" x 47⁵/₈"

5" x 3⁵/₈" x 47⁵/₈"

6" x 3⁵/₈" x 47⁵/₈"

8" x 3⁵/₈" x 47⁵/₈"

10" x 3⁵/₈" x 47⁵/₈"

12" x 3⁵/₈" x 47⁵/₈"

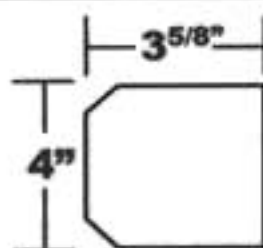

3/4" Round

4" x 3⁵/₈" x 47⁵/₈"

5" x 3⁵/₈" x 47⁵/₈"

6" x 3⁵/₈" x 47⁵/₈"

8" x 3⁵/₈" x 47⁵/₈"

10" x 3⁵/₈" x 47⁵/₈"

12" x 3⁵/₈" x 47⁵/₈"

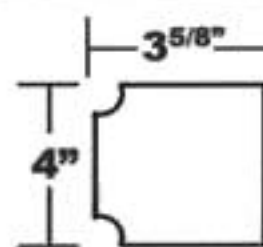

Cove

4" x 3⁵/₈" x 47⁵/₈"

5" x 3⁵/₈" x 47⁵/₈"

6" x 3⁵/₈" x 47⁵/₈"

8" x 3⁵/₈" x 47⁵/₈"

10" x 3⁵/₈" x 47⁵/₈"

12" x 3⁵/₈" x 47⁵/₈"

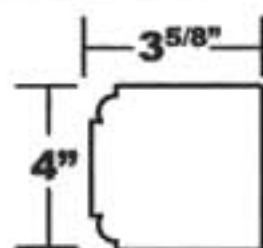

Base & Rail

Parkside Rail

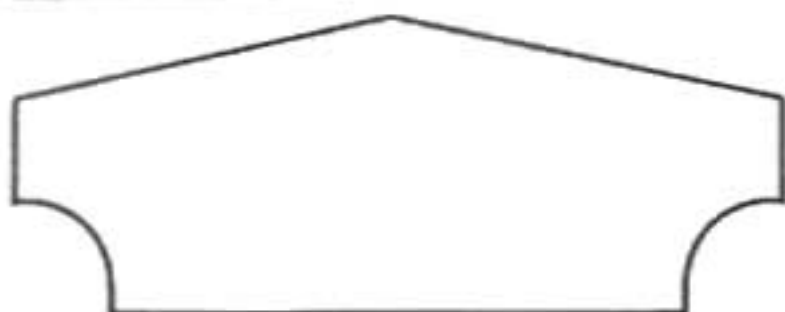

Bullnose Rail



Crown Base/Rail



Cove Base/Rail



Chamfered Base/Rail



Base & Rail

Parkside Rail

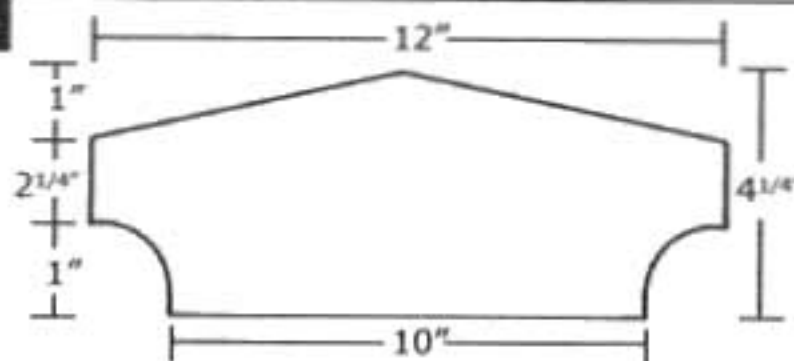

Bullnose Rail

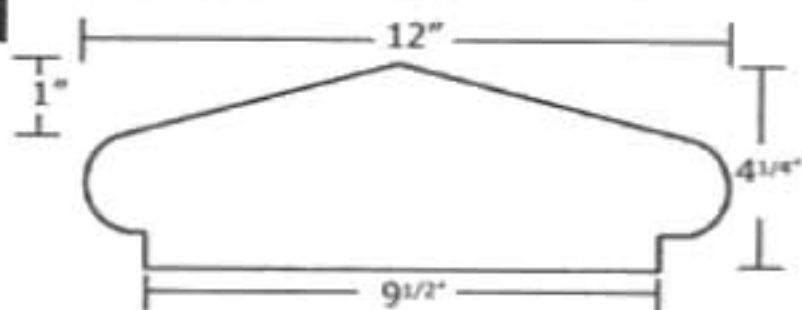

Crown Base/Rail

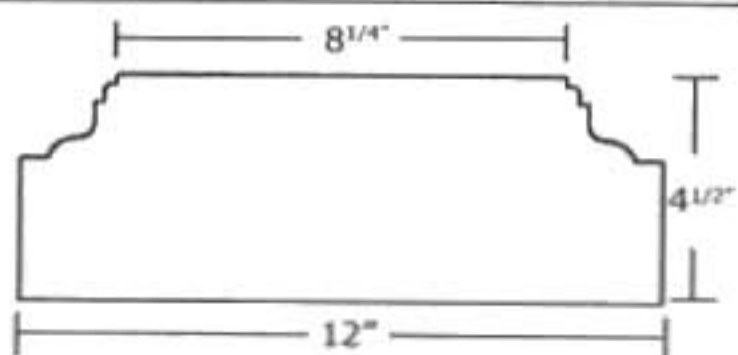

Cove Base/Rail

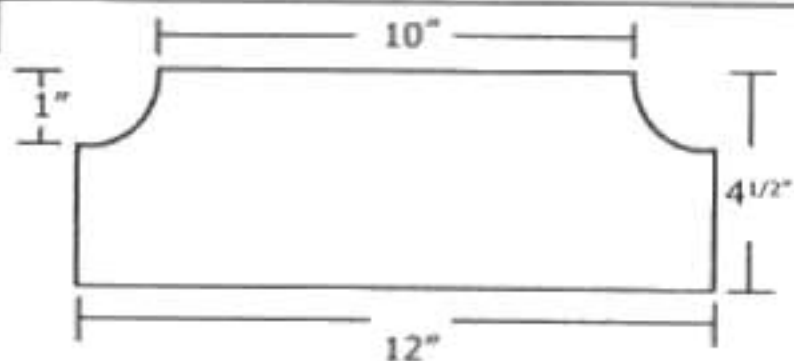

Chamfered Base/Rail

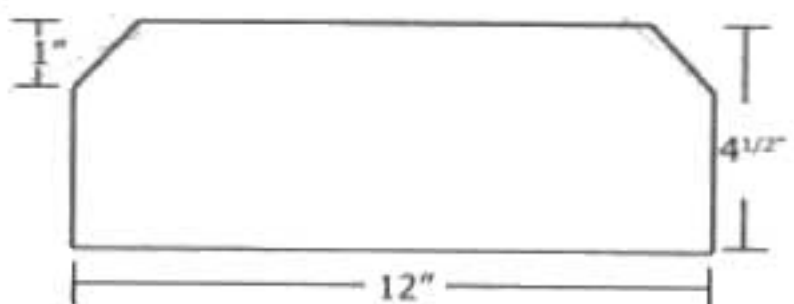

Bricks

Marquis Flower Brick



7 5/8"

Bricks

Stylized Flower Brick

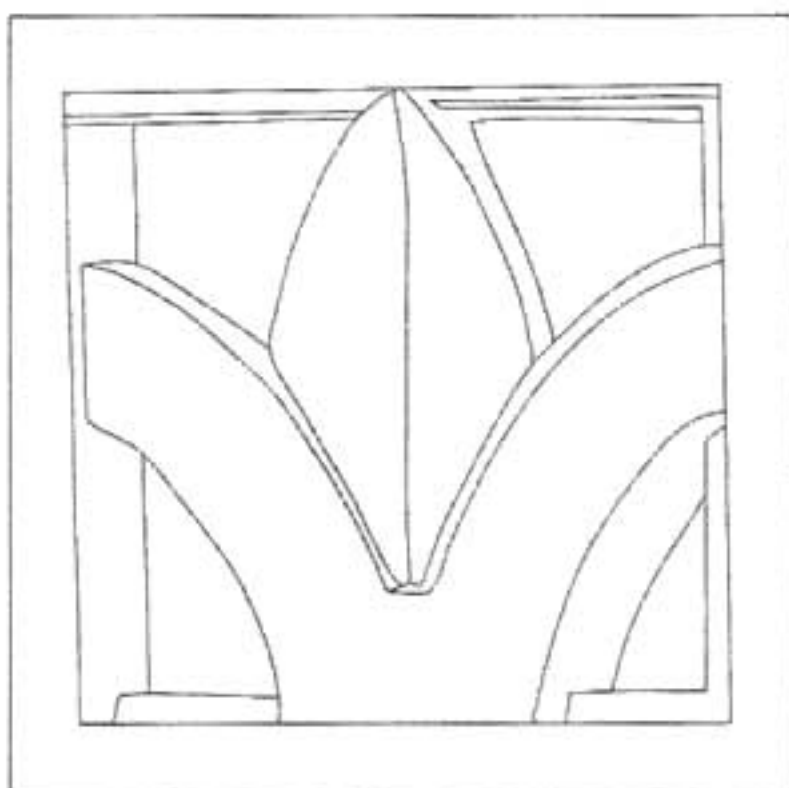
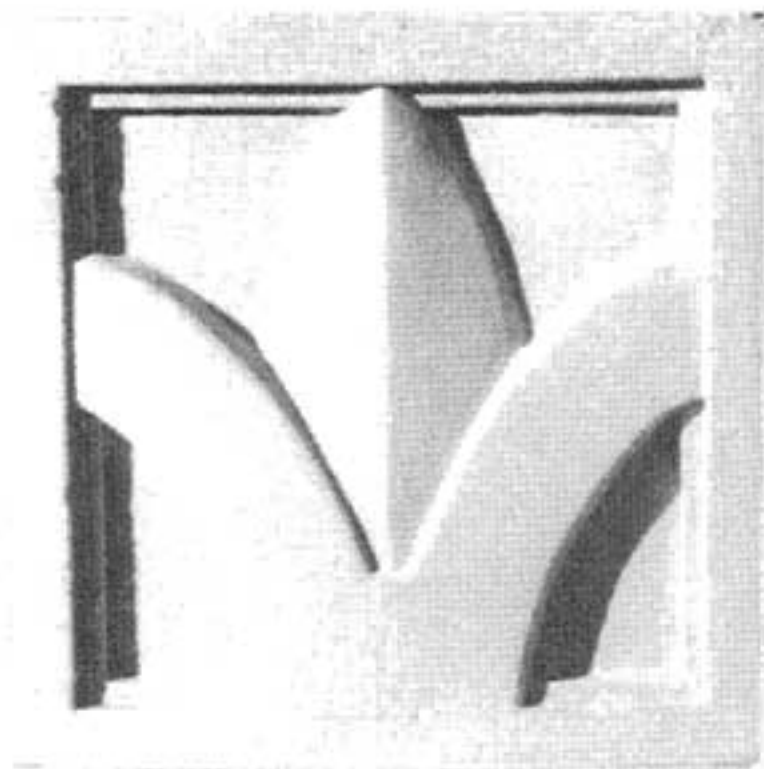

6 1/2"

Bricks

Simple Flower Brick

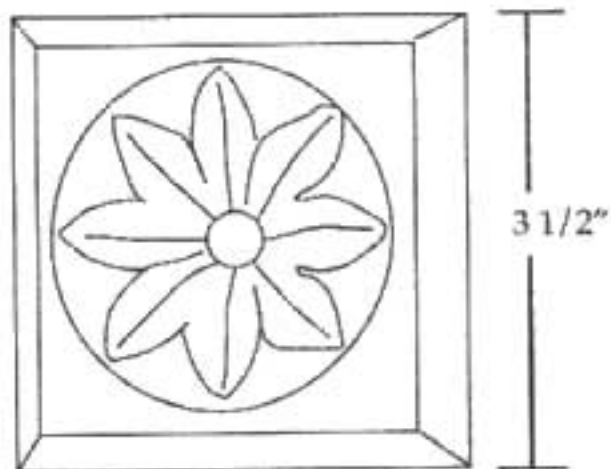
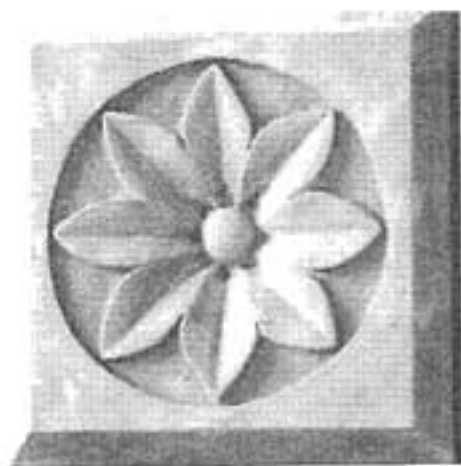

Bricks

Horizontal Flower Brick

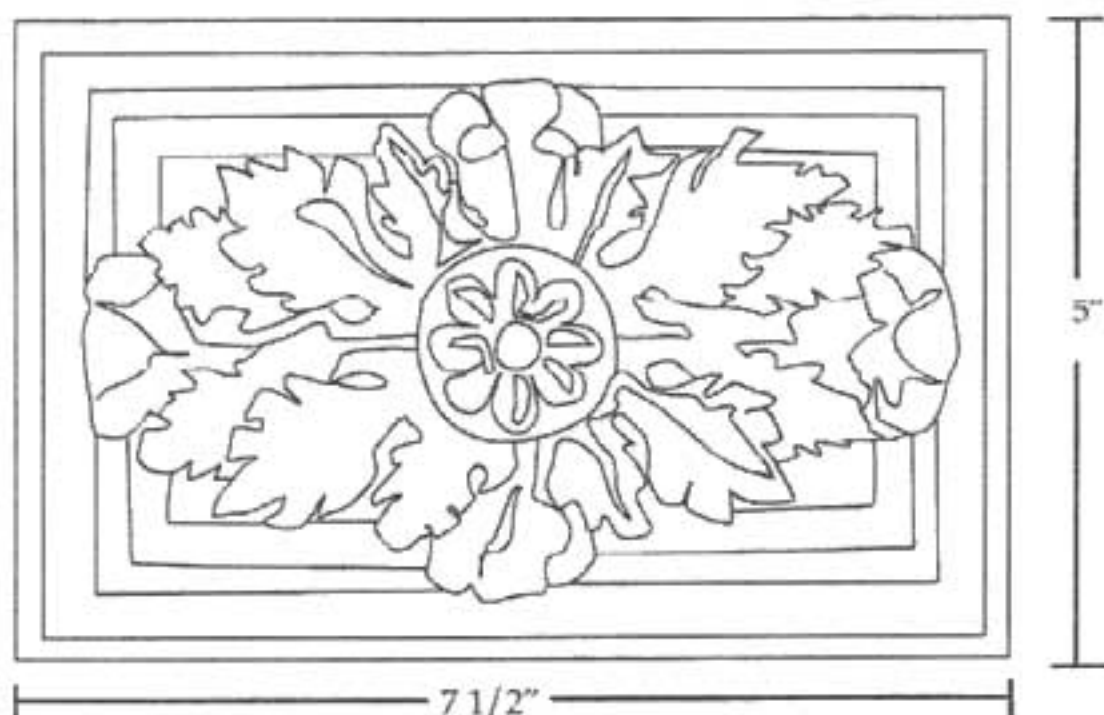

Bricks

Small Rose Brick

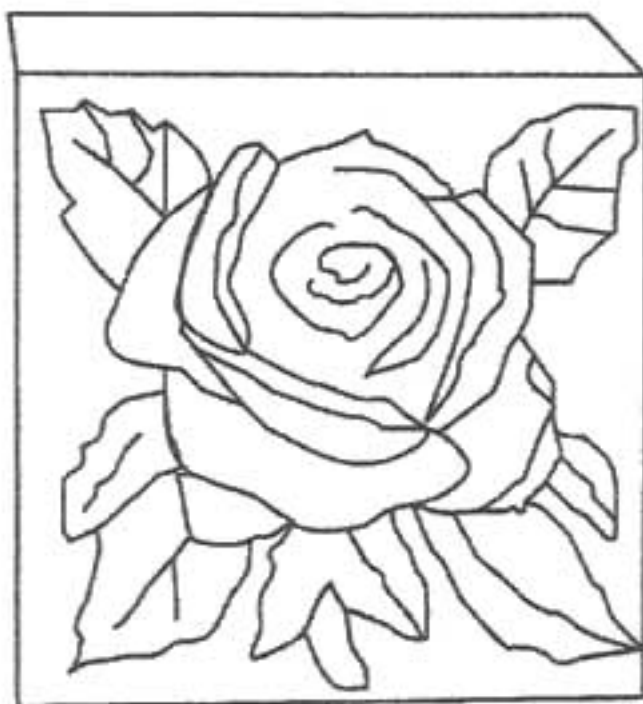

Corbels

Corbel C-1



Corbel C-2



Corbel C-3



Corbel C-4



Corbels

Corbel C-5



Corbel C-6

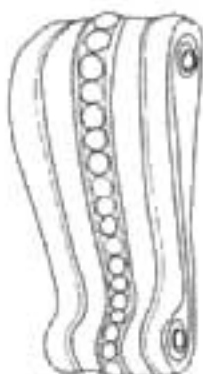

Corbel C-7



Corbel C-8



Corbels

Corbel C-9

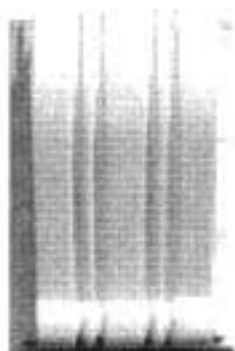

Corbel C-10



Corbel C-11



Jack Arches

Plain Jack Arch w/ Recessed Keystone

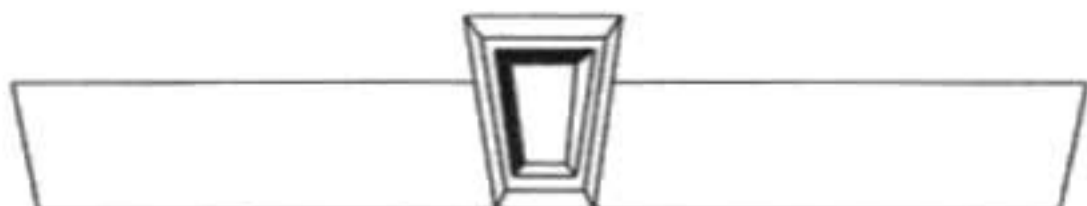

Plain Jack Arch w/ Batwing Keystone



Beveled Jack Arch w/ Beveled Keystone

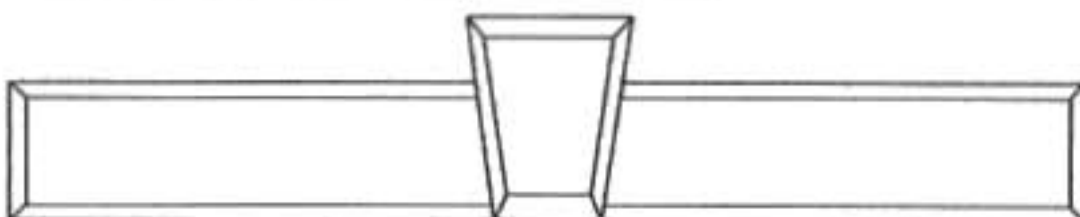

Jack Arches

Plain Jack Arch w/ Recessed Keystone



Plain Jack Arch w/ Batwing Keystone

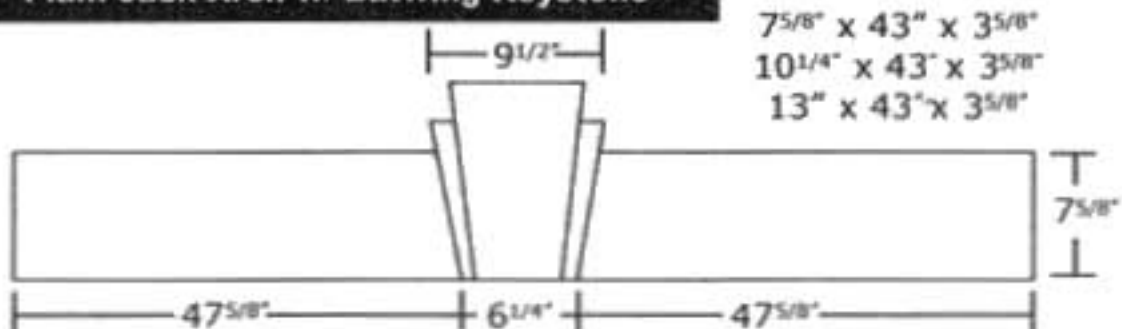

Beveled Jack Arch w/ Beveled Keystone

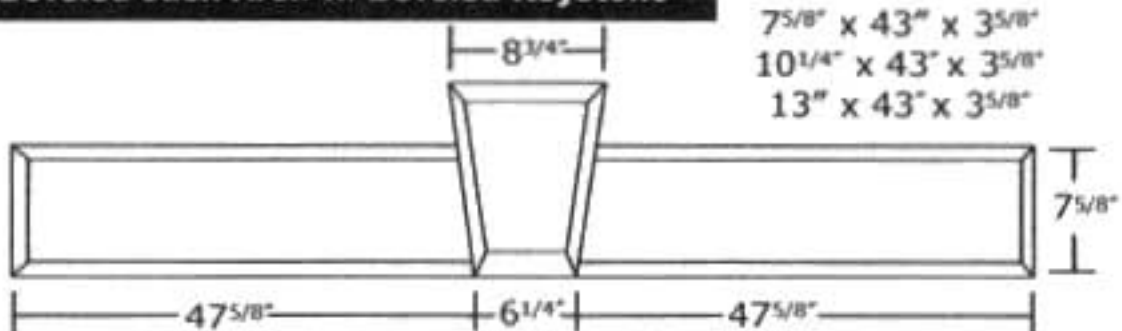

Keystones

Plain

3 Course
4 Course
5 Course
6 Course



Beveled

3 Course
4 Course
5 Course
6 Course

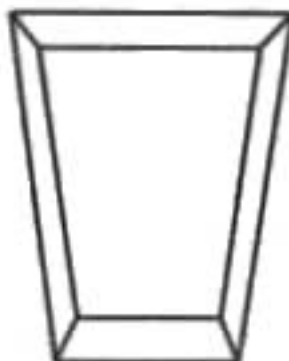

Recessed

4 Course



Batwing

4 Course
5 Course

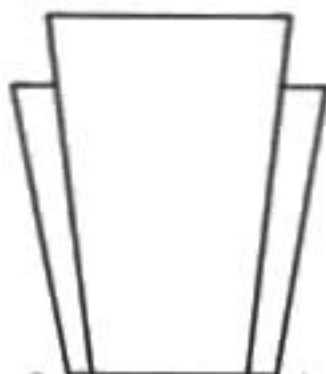

Keystones

3 Course - 7^{5/8}"h

Plain - 6" x 4" x 3^{5/8}"

Bevel - 6^{1/4}" x 4^{1/2}" x 3^{5/8}"

4 Course - 10^{1/4}"h

Plain - 8^{1/2}" x 6" x 3^{5/8}"

Bevel - 8^{3/4}" x 6^{1/4}" x 3^{5/8}"

Batwing - 9^{1/2}" x 6^{1/4}" x 3^{5/8}"

Recessed - 8^{3/4}" x 6^{1/4}" x 3^{5/8}"

5 Course - 13" h

Plain - 9^{1/2}" x 6 x 3^{5/8}"

Bevel - 9^{1/4}" x 6^{1/4}" x 3^{5/8}"

6 Course - 15^{5/8}"h

Plain - 10 x 6^{1/4}" x 3^{5/8}"

Bevel - 9^{1/4}" x 6^{1/4}" x 3^{5/8}"

Post Caps

Pyramid Post Cap

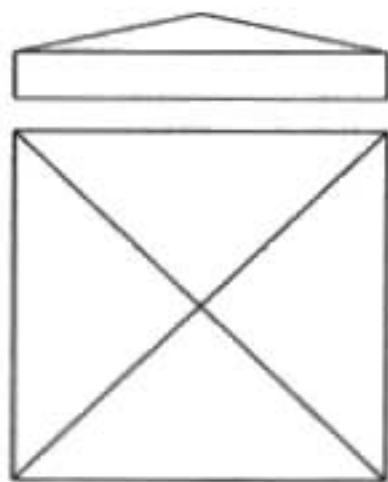

Flat Post Cap

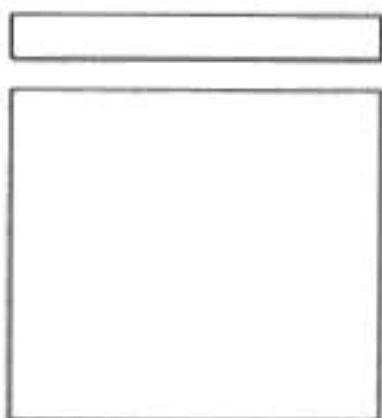

Chamfered Post Cap



Post Caps

Pyramid Post Cap 5" to 3"

18" x 18"	30" x 30"
20" x 20"	32" x 32"
22" x 22"	34" x 34"
24" x 24"	36" x 36"
26" x 26"	38" x 38"
28" x 28"	40" x 40"

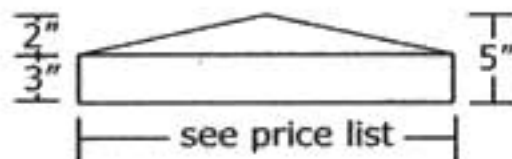

Flat Post Cap

18" x 18"	30" x 30"
20" x 20"	32" x 32"
22" x 22"	34" x 34"
24" x 24"	36" x 36"
26" x 26"	38" x 38"
28" x 28"	40" x 40"

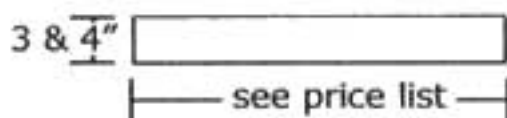

Chamfered Post Cap

18" x 18"	30" x 30"
20" x 20"	32" x 32"
22" x 22"	34" x 34"
24" x 24"	36" x 36"
26" x 26"	38" x 38"
28" x 28"	40" x 40"

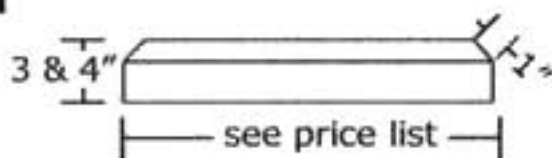

Quoins

Plain

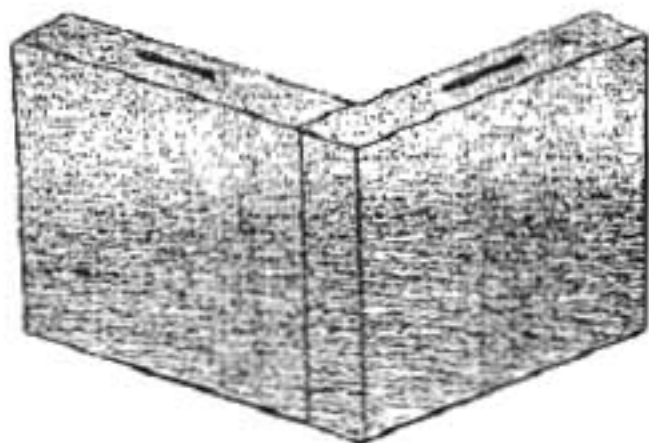

Beveled

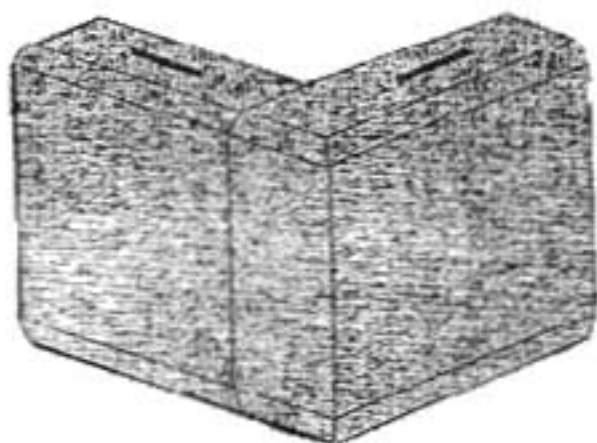

Rustication

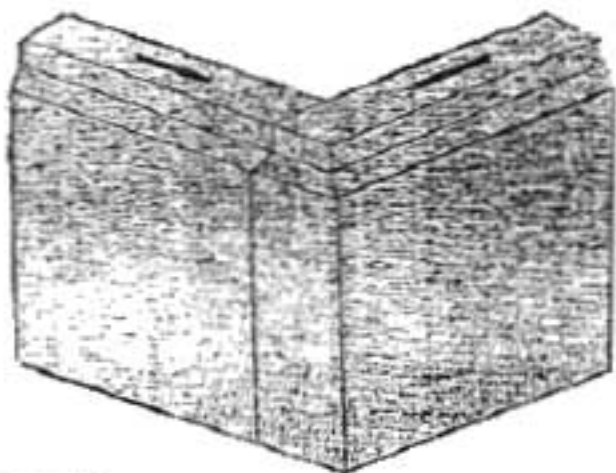

Quoins

Plain

Standard	Face Pc.	Return Pc
4 Course	16"x10 ¹ / ₄ "x3 ⁵ / ₈ "	12x10 ¹ / ₄ "x3 ⁵ / ₈ "
5 Course	16"x13"x3 ⁵ / ₈ "	12x13"x3 ⁵ / ₈ "

Staggered	Face Pc.	Return Pc
4 Course	20"x10 ¹ / ₄ "x3 ⁵ / ₈ "	12x10 ¹ / ₄ "x3 ⁵ / ₈ "
5 Course	20"x13"x3 ⁵ / ₈ "	12x13"x3 ⁵ / ₈ "

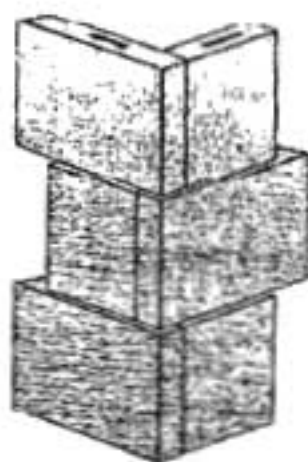
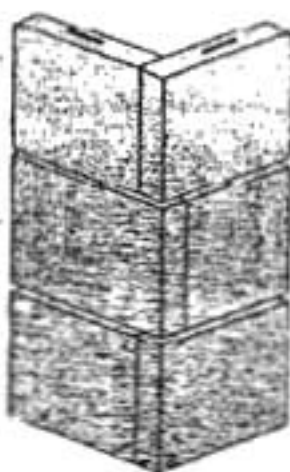

Beveled

Standard	Face Pc.	Return Pc
4 Course	16"x10 ¹ / ₄ "x3 ⁵ / ₈ "	12x10 ¹ / ₄ "x3 ⁵ / ₈ "
5 Course	16"x13"x3 ⁵ / ₈ "	12x13"x3 ⁵ / ₈ "

Staggered	Face Pc.	Return Pc
4 Course	20"x10 ¹ / ₄ "x3 ⁵ / ₈ "	12x10 ¹ / ₄ "x3 ⁵ / ₈ "
5 Course	20"x13"x3 ⁵ / ₈ "	12x13"x3 ⁵ / ₈ "

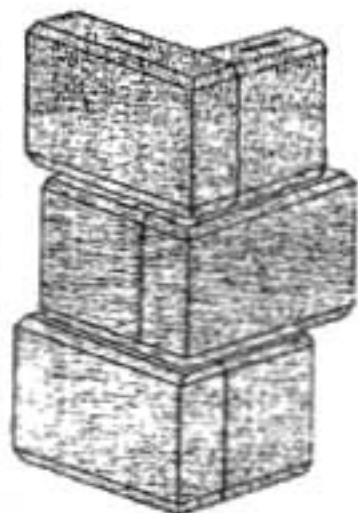
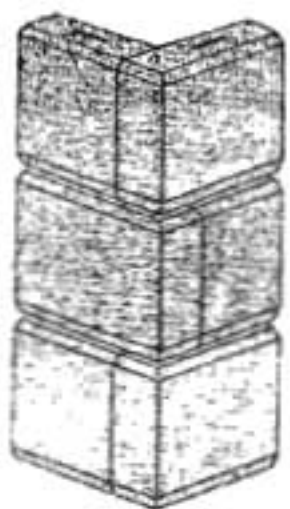

Rustication

Standard	Face Pc.	Return Pc
4 Course	16"x10 ¹ / ₄ "x3 ⁵ / ₈ "	12x10 ¹ / ₄ "x3 ⁵ / ₈ "
5 Course	16"x13"x3 ⁵ / ₈ "	12x13"x3 ⁵ / ₈ "

Staggered	Face Pc.	Return Pc
4 Course	20"x10 ¹ / ₄ "x3 ⁵ / ₈ "	12x10 ¹ / ₄ "x3 ⁵ / ₈ "
5 Course	20"x13"x3 ⁵ / ₈ "	12x13"x3 ⁵ / ₈ "

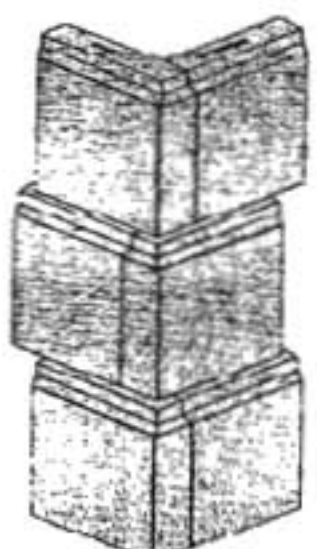
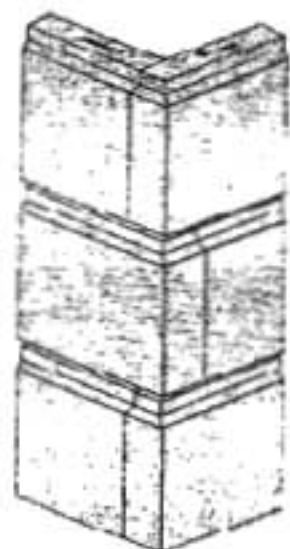

Sills

Sloped Sill 5" to 4"

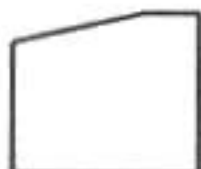

Sloped Sill 4" to 3"



Flat Sill



Sills

Sloped Sill 5" to 4"

Available in 4'
lengths (47^{5/8}")

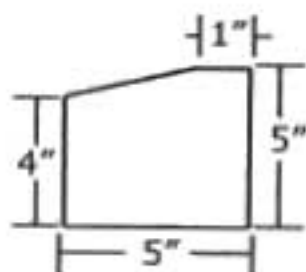

Sloped Sill 4" to 3"

Available in 4'
lengths (47^{5/8}")

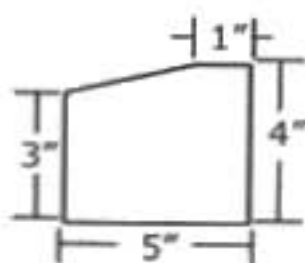

Flat Sill

Available in 4'
lengths (47^{5/8}")

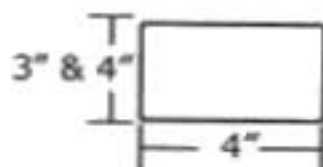

Trim Detail

St. Louis Brick

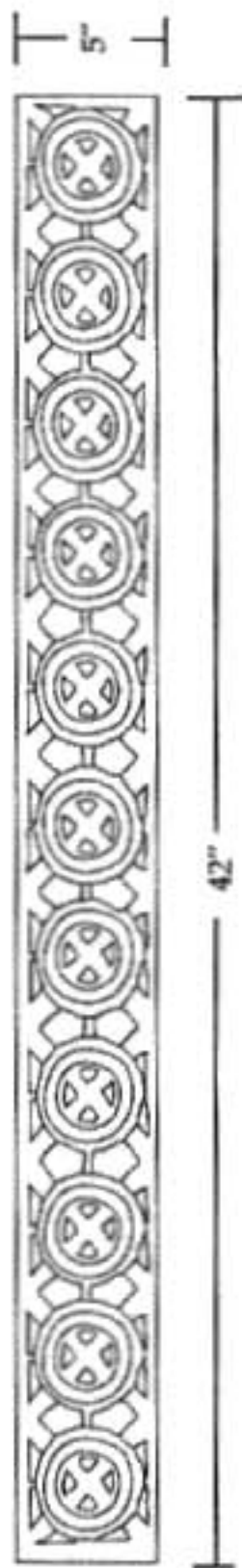

Trim Detail

Leaves and Berries

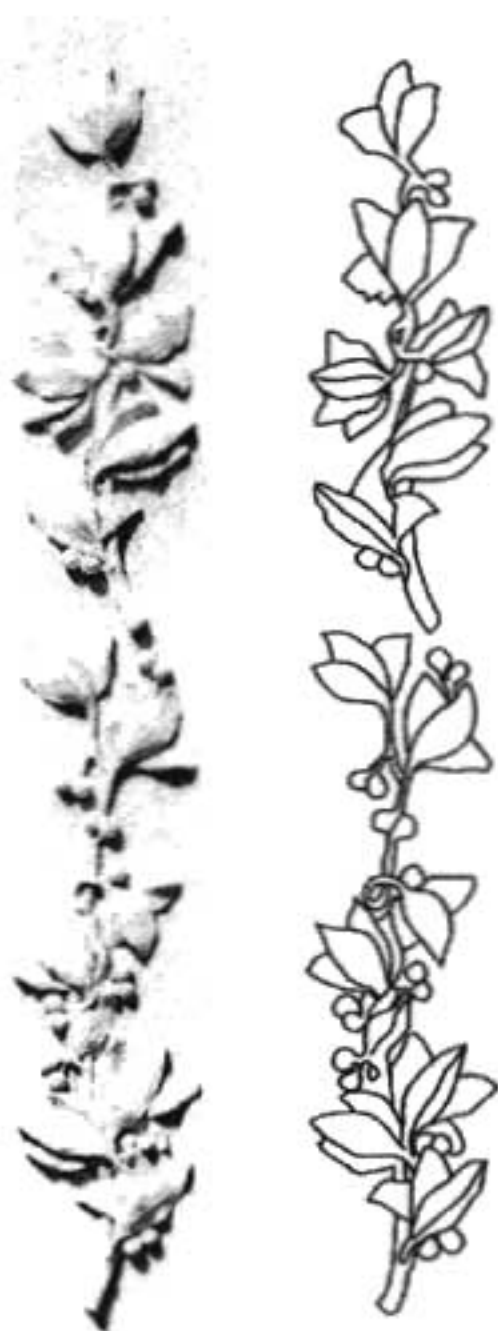

Trim Detail

Heartland



Trim Detail

Corinthian

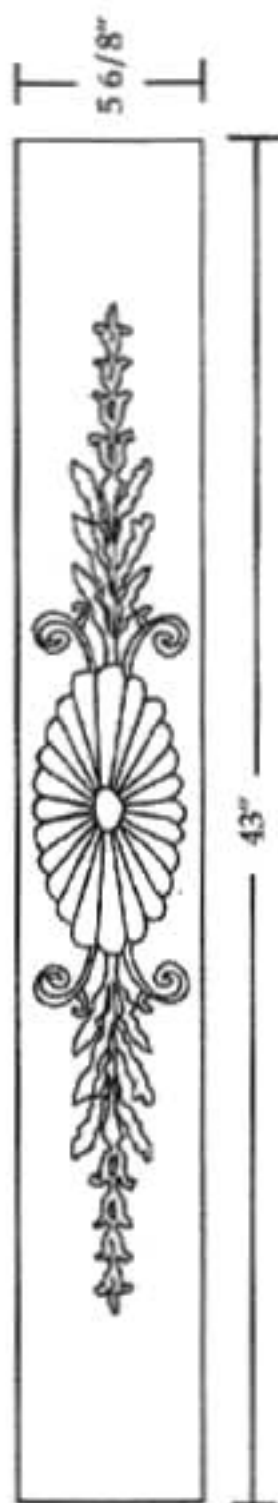
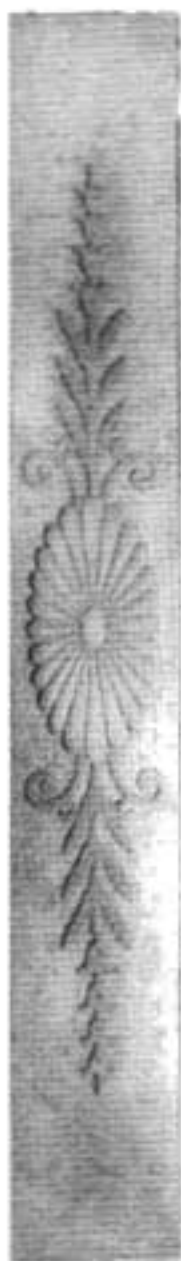

Trim Detail

Dentil Trim



Trim Detail

Legacy Trim

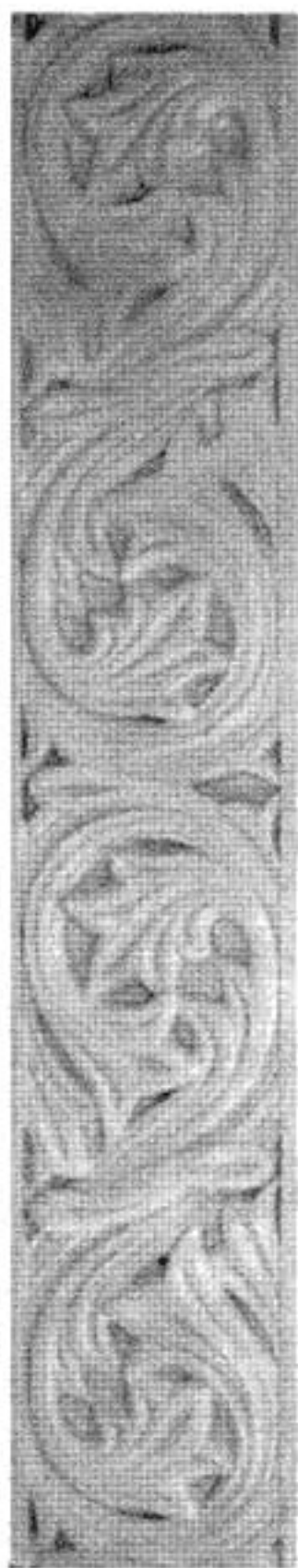

Brickstone Studios

Trim Detail

Quarter Round



Veneer Panels

Veneer Panels

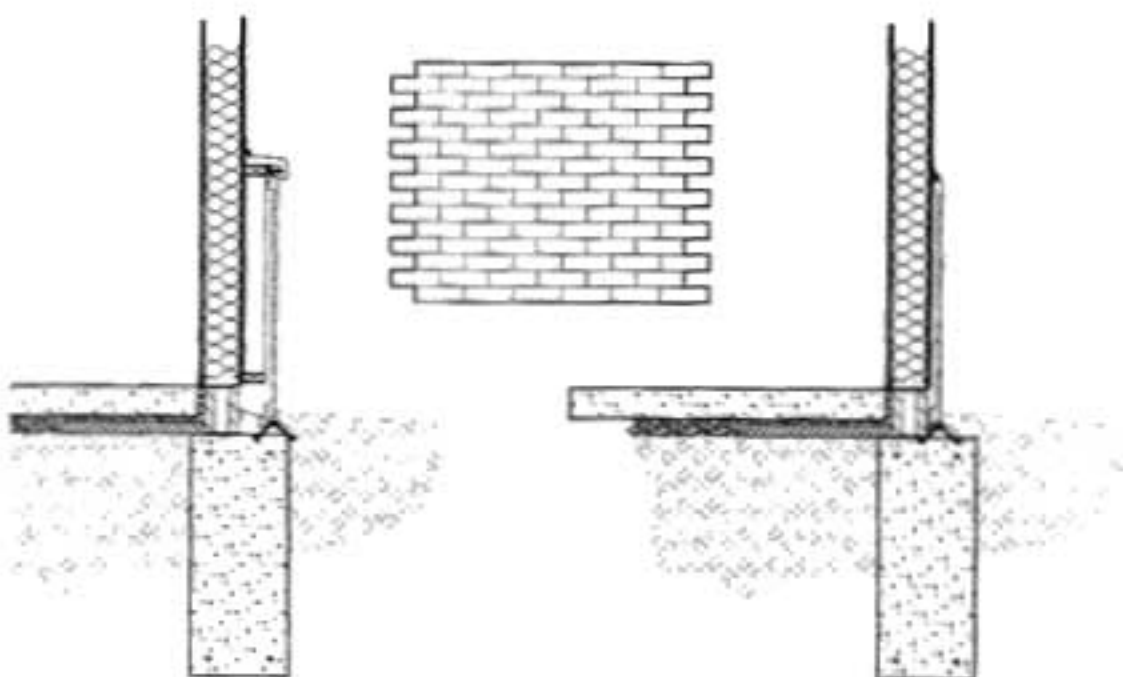
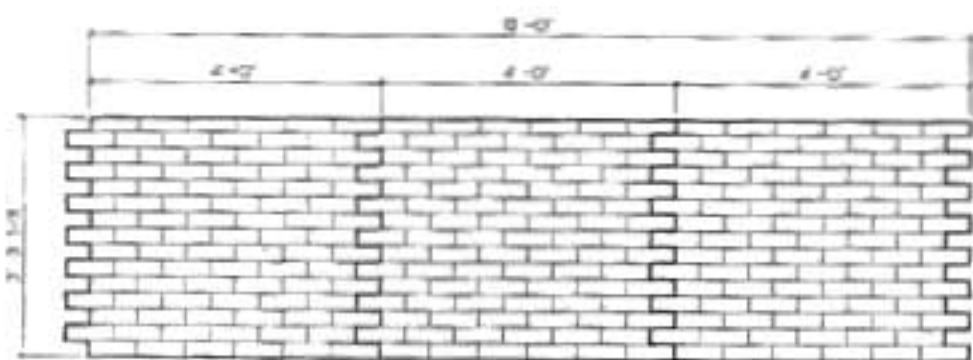

Veneer Panels

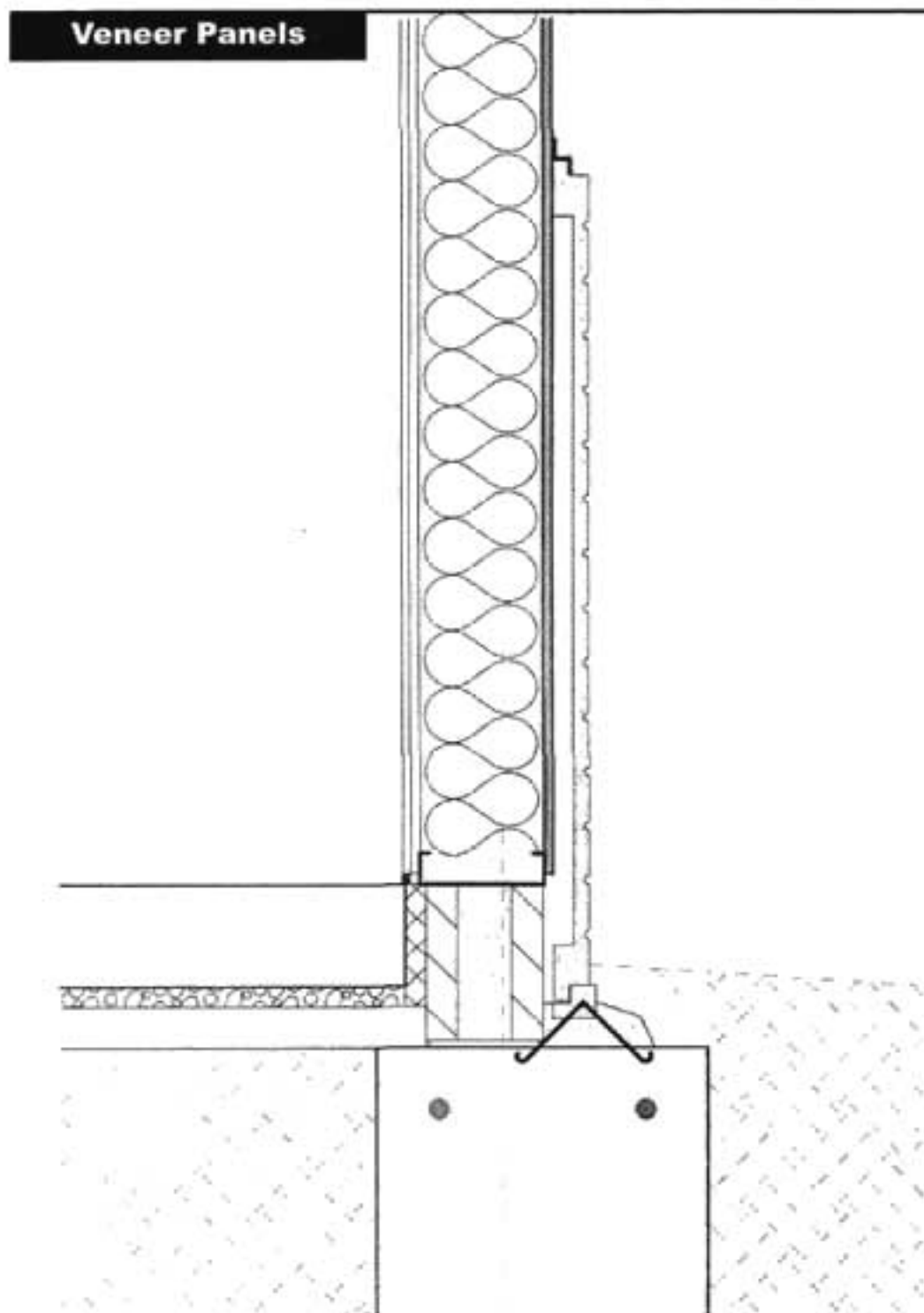

Veneer Panels

Veneer Panels

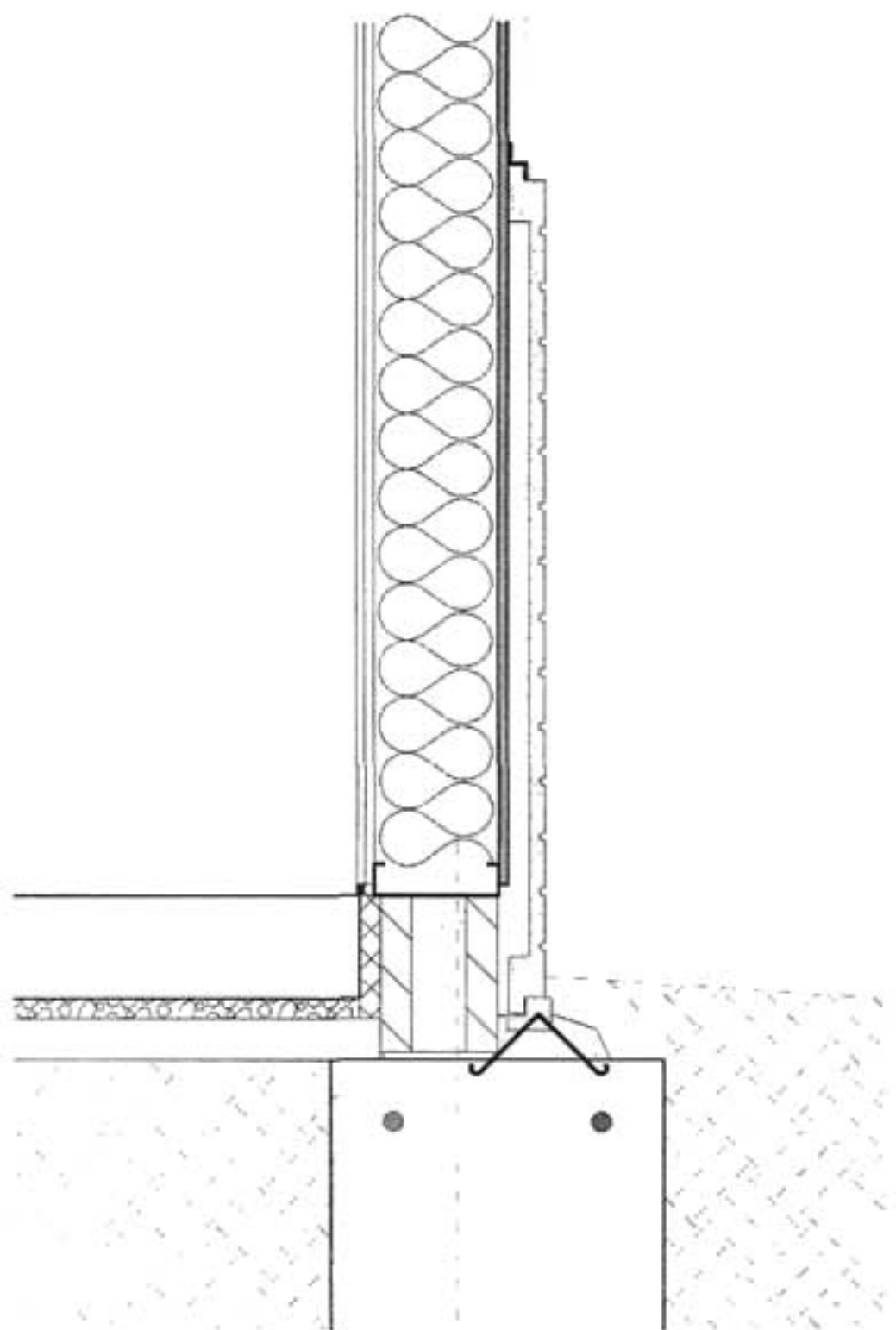

Veneer Panels

Veneer Panels

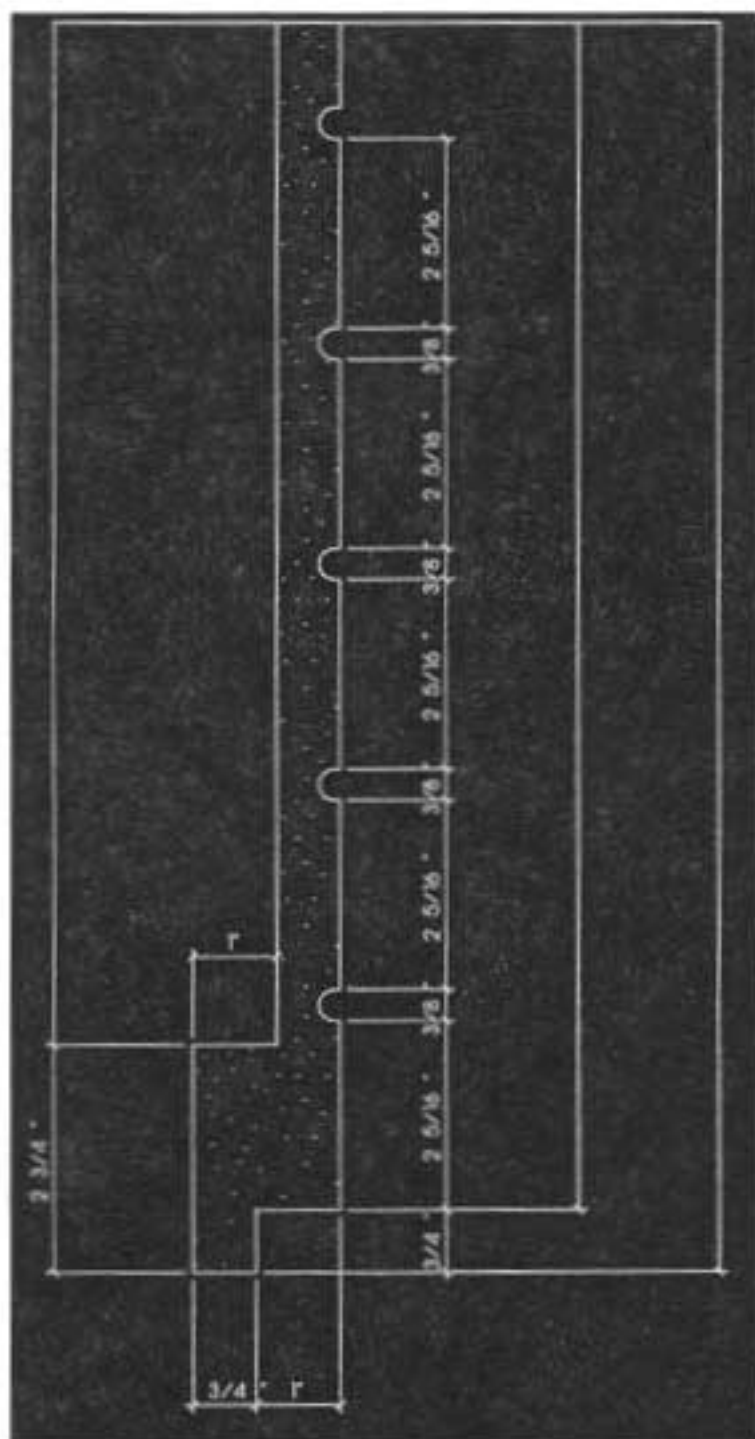

Veneer Panels

Veneer Panels

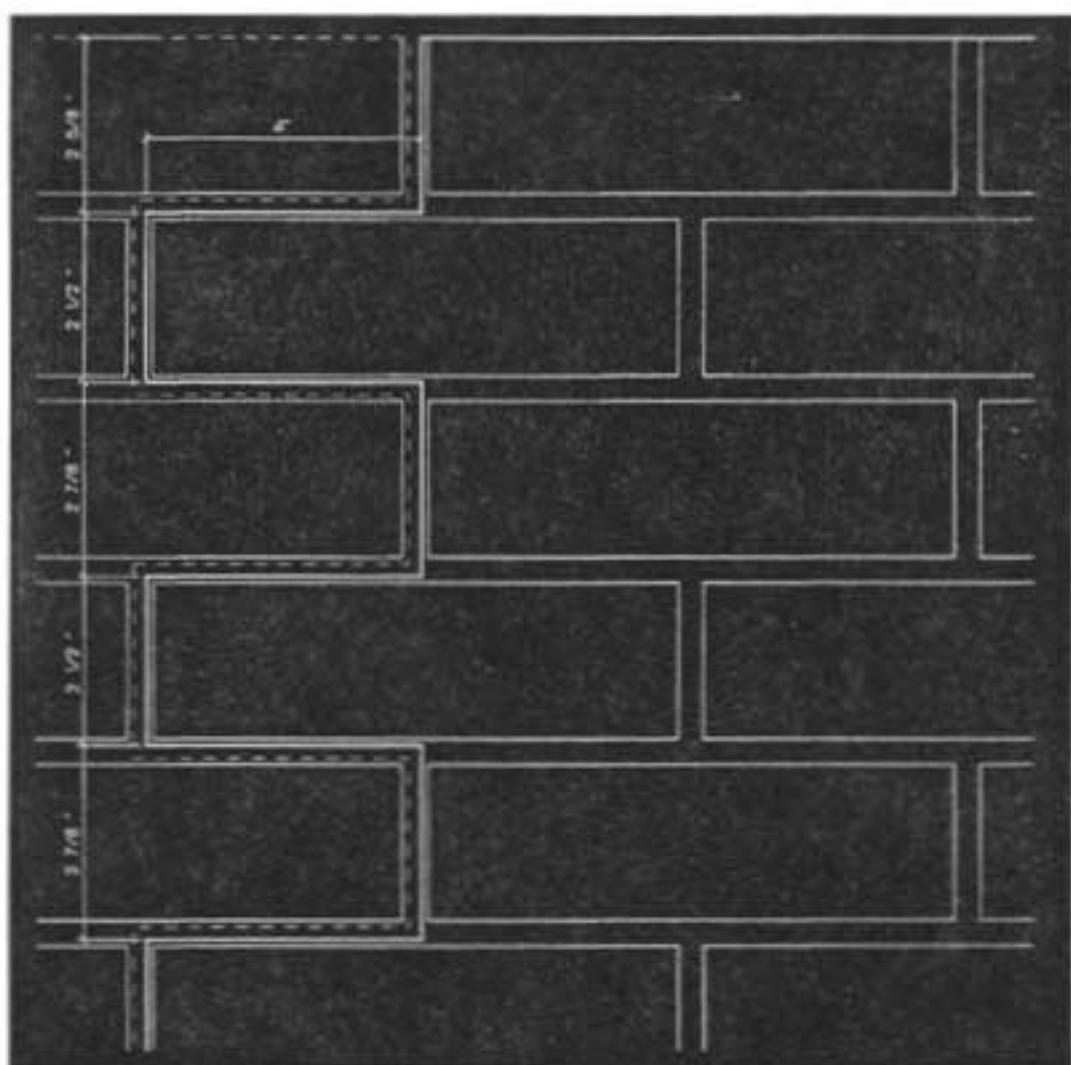

Veneer Panels

Veneer Panels

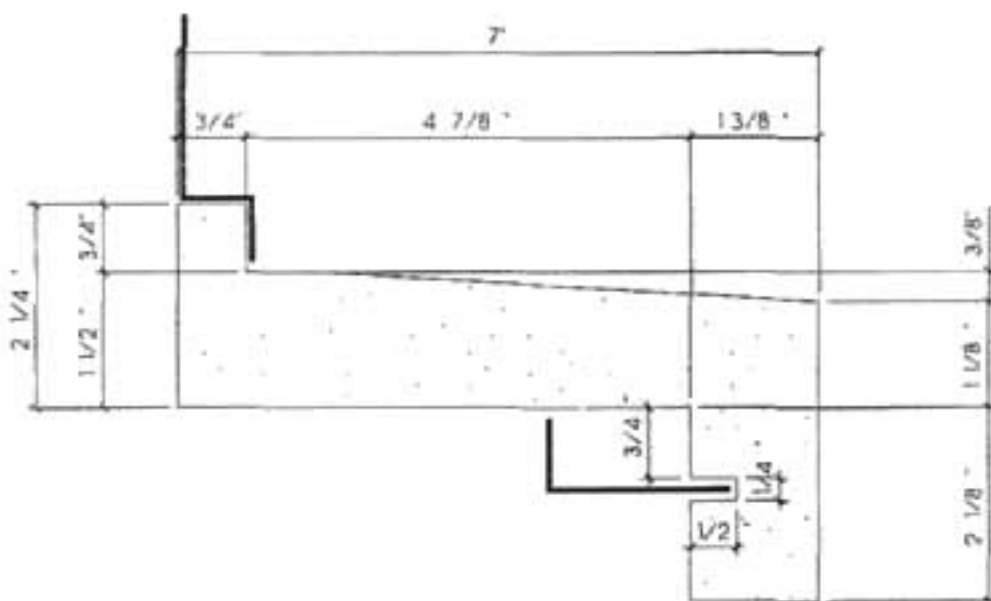

Veneer Panels

Veneer Panels

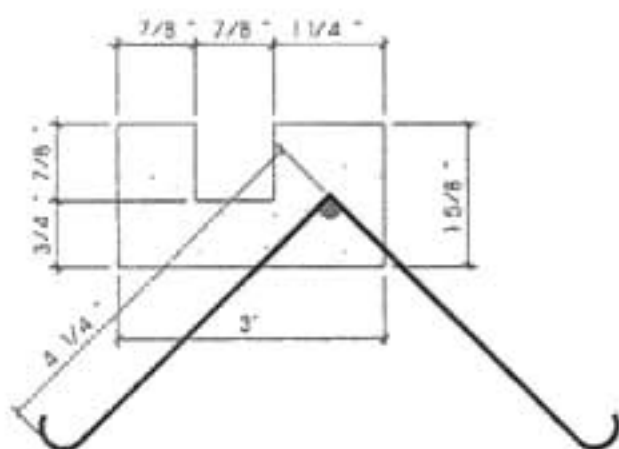
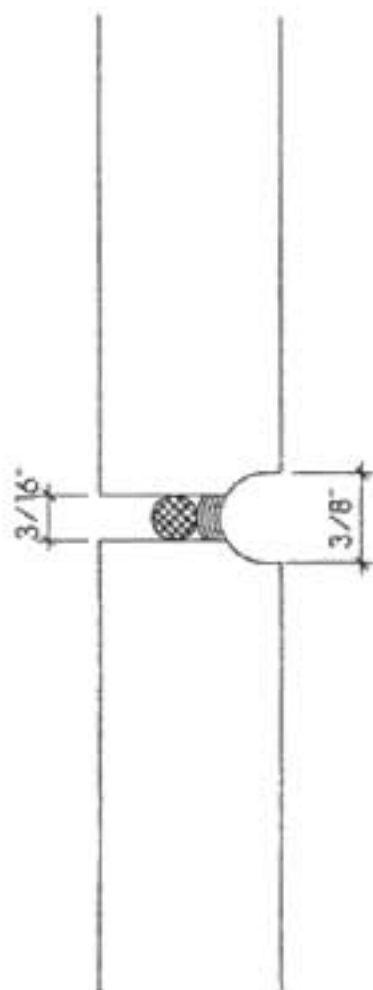
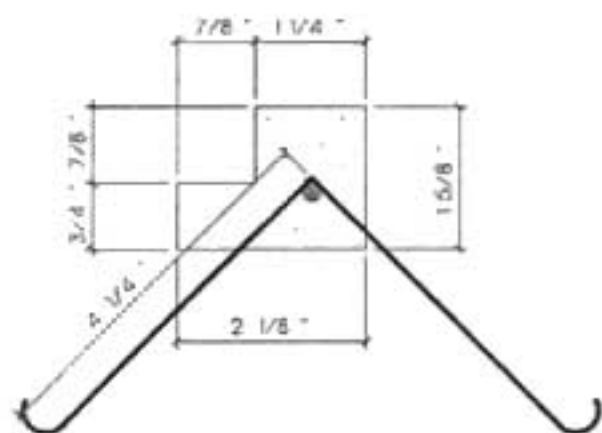

Wall Coping

Double Slope 5" to 3"



Single Slope 5" to 3"



Chamfered



Flat Stock



Wall Coping

Double Slope 5" to 3"

10" 16"
12" 18"
14" 20"

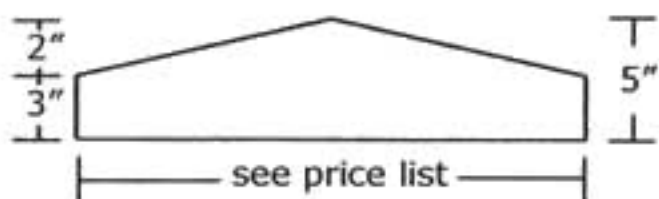

Single Slope 5" to 3"

10" 16"
12" 18"
14" 20"

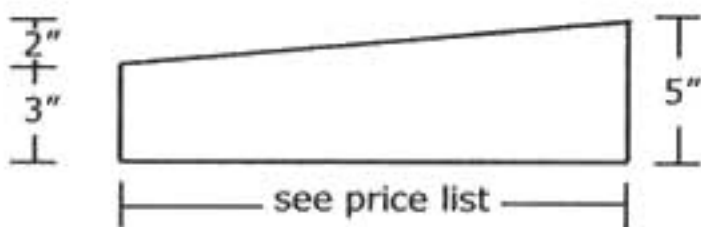

Chamfered

10" 16"
12" 18"
14" 20"

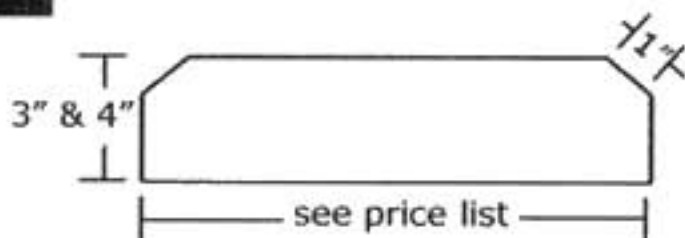

Flat Stock

10" 16"
12" 18"
14" 20"

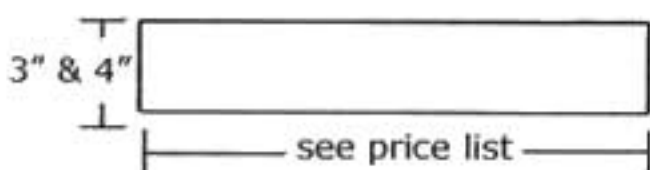

Arch Elements

Examples

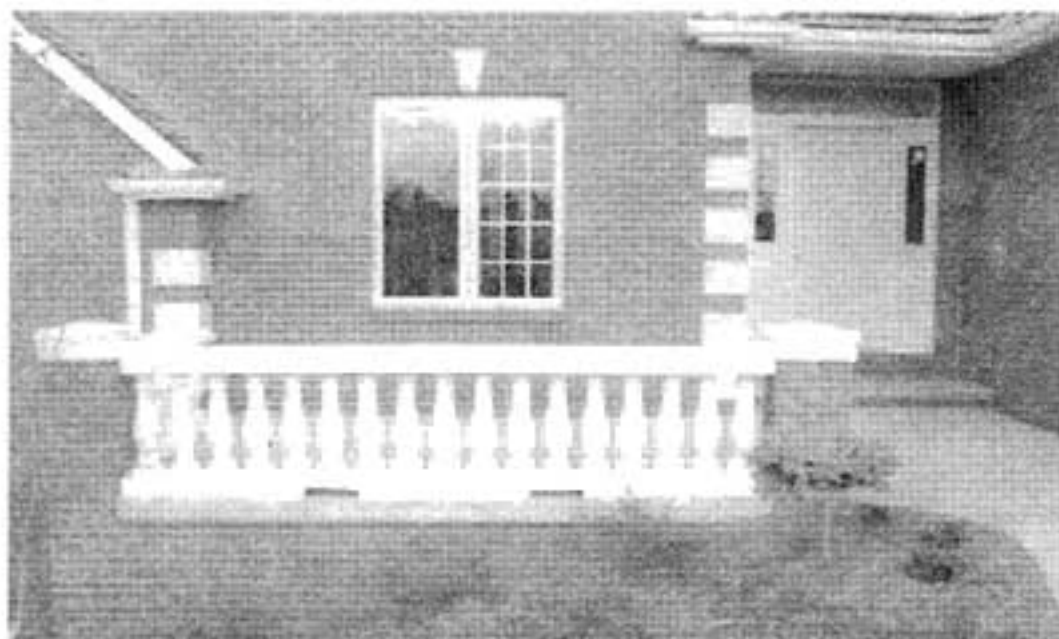

Arch Elements

Examples

